

WOLF

ESTD 1834



2022

WOLF
ESTD 1834

PROTECTING LEGACY

Over 185 years old,
five generation family-owned brand,
crafting the spaces where legacies live.





LEFT: PHILIP WOLF IV

Our legacy...

1834

Philip Wolf I, a successful German silversmith, discovered that his silver pieces sold better when presented in beautiful boxes. As he began selling more boxes than silver, he refocused his craft thus marking the beginning of WOLF.

1962

Over time, his highly automated factory employed over 300 people and was recognised as the largest manufacturer of jewellery boxes and display materials for all of Great Britain and much of Europe.

1895

Then came his son Philip Wolf II, who convinced his father to move the business to Malmö, Sweden. As time passed, his sons, Ernst and Philip III, proudly continued the tradition of box making.

1988

With the economy and business flourishing in England, the time was right for the Wolf family to assume the biggest challenge they had ever undertaken: tackling the USA and Canadian markets. It was up to Simon Philip V, with guidance from his father Philip IV, to persevere and continue to expand and diversify the company.

1930

Philip Wolf III continued to expand the Swedish factory into its third generation of box making. Progress was slow but steady and then, in 1962, his first son, Philip Wolf IV, immigrated to England to open a new factory.

TODAY

The Wolf family legacy proudly continues, focusing on innovative designs, technological advancements, the pursuit of the perfect design and the protection of your legacies.



Your legacy...

As a five-generation family company, we understand that extraordinary objects are representations of extraordinary moments in life.

Since 1834, the WOLF mark has been a symbol of decades of innovation and the pursuit of the perfect design.

We believe for a legacy to endure it must be nourished and upheld.

Every day in beautiful WOLF cases around the world, centuries-old treasures live side-by-side with exquisite new designs.

We are dedicated to honouring people's stories and the legacies they entrust to us.

Protect your legacy with WOLF





PATENTED TECHNOLOGY

**OUR JEWELLERY BOXES
FEATURE LUSTERLOC™**

Jewellery begins to lose its luster with
air contact and our patented LusterLoc™

formula neutralises the process.

LusterLoc™ protects your jewellery

for up to 35 years.

PATENTED TECHNOLOGY AND DESIGN

**ONLY OUR WATCH WINDERS
COUNT TURNS PER DAY**

WOLF, first to count turns per day, first with the unique return to start feature, first to engineer a safe lock-in cuff, now first with their patent pending "Dynamic Cuff".

One cuff, three sizes...genius.

Why guess when you can be precise,

WOLF, always innovating.

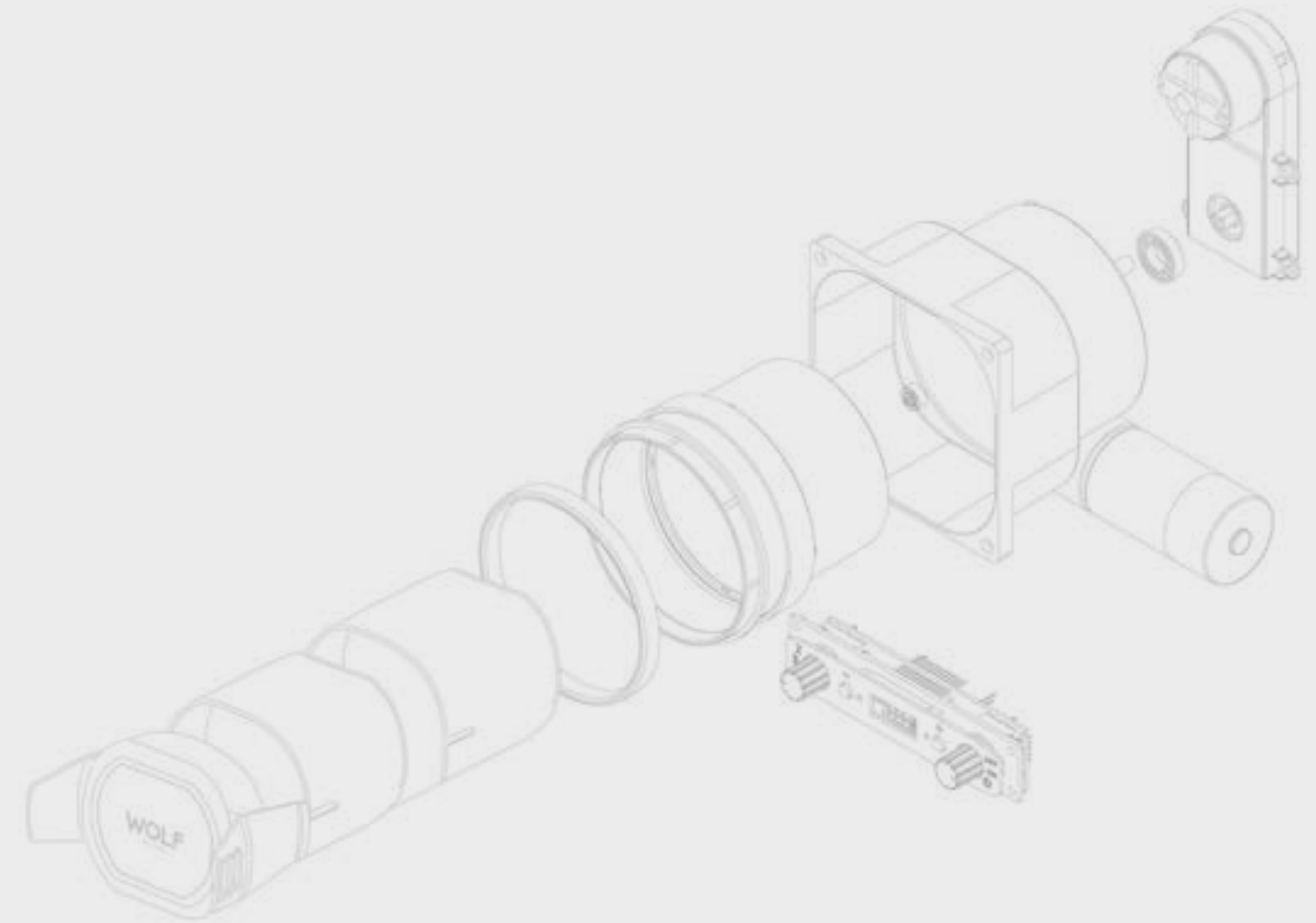

Sustainability

Over the last several years, we have deepened our commitment to sustainability across the company.

We source sustainable packaging and use materials like 100% recycled leather.

Because it matters to us, but also because our commitment to quality is intertwined with the need for sustainable processes and materials.

Protecting your legacy, protecting the planet.

Honouring Craft at Every Level



Our workshops and the people who work in them are the bedrock of our business. We provide safe working conditions, liveable wages and work hard to ensure equal labour rights. Because the quality of life of our artisans directly affects the quality of our products and because we care about our impact on the environment, we also ensure that our factories meet emissions standards and practices.

Impact is in the Details



We only use recyclable, sustainable and eco-friendly packaging that is made of 70% post-consumer recycled waste. So you can feel good about unboxing your WOLF product as all packaging can be re-used or placed in a recycling bin.

Leather, Reimagined



Our CEO Simon Wolf has continued his family legacy in many ways, including a deep commitment to environmentalism and protection of animals. To protect your legacy, which is WOLF's core aim, we must do our part to protect the health of the planet. All of our watch winders are wrapped in 100% vegan leather, because the highest quality and luxury can also be sustainable.

New and Innovative Packaging



At WOLF, we only use certified FSC 100% recycled paper, certified recycled corrugated cardboard and 100% recycled cotton and polyester materials. Our new accessories collection is 95% sustainable, with materials made from recycled PVC, apple pulp and plastic bottles.

Minimising Effects on Planet Earth



WOLF has a long history of caring about climate. Philip Wolf III wrote about 'climate change', in his book, 'Land Drainage and its Dangers as Experienced in Sweden', 58 years before the term had been coined. Philip wrote on subjects related to how we were already affecting the climate of the earth.

Family Legacy of Conservation



Simon Wolf's grandfather created the Swedish Salmon and Trout Association. The inauguration took place in August of 1948 when he opened Håstad Mill. As a lifelong fisherman who cared deeply about the water quality and the impact the fishing industry had on the planet, it was one of his greatest achievements that continues to inspire Simon Wolf's commitment to conservation.

WATCH WINDERS / PAGE 16

PROGRAMMABLE WATCH WINDERS

AXIS	18
BRITISH RACING.....	20
MEMENTO MORI	22
MODULE 4.1.....	24
PALERMO.....	26
ROADSTER.....	28
VICEROY.....	30

PRE-PROGRAMMABLE WATCH WINDERS

CUB.....	32
ELEMENTS.....	34
NAVIGATOR.....	36

APP-CONTROLLED WATCH WINDERS

ATLAS	38
CHURCHILL.....	40
REGENT.....	42

WATCH ROLLS / PAGE 44

AXIS	46
BLAKE	46
BRITISH RACING.....	46
ELEMENTS.....	48
MEMENTO MORI	48
NAVIGATOR.....	48
PALERMO.....	50
ROADSTER	50

WATCH BOXES / PAGE 52

AXIS	54
BRITISH RACING.....	56
ELEMENTS.....	58
MEMENTO MORI.....	60
PALERMO.....	62
ROADSTER.....	64
VICEROY.....	66

JEWELLERY BOXES / PAGE 68

CAROLINE	70
MARRAKESH.....	72
PALERMO.....	74
SOPHIA	76
VAULT.....	78
ZOE.....	84

TRAVEL CASES / PAGE 86

CAROLINE	88
MARIA	90
MARRAKESH.....	92
PALERMO.....	94
SOPHIA	96
ZOE.....	98

SAFES / PAGE 100

ATLAS	104
CHURCHILL.....	108

LUXURY ACCESSORIES / PAGE 120

MIMI	122
SIGNATURE.....	124
W	128

COLLABORATIONS / PAGE 130

ANALOG/SHIFT.....	132
BEA BONGIASCA	134
CASSANDRA.....	136
WM BROWN	138



WATCH WINDERS

A WOLF watch winder is a handmade precision instrument that focuses on the health of your watch using patented technology. Only a WOLF counts Turns per Day, all other winders simply use time to estimate rotations. With a lock in dynamic cuff, allowing for varying wrist sizes and unique return to start feature, WOLF's winders combine clever design with innovative technology. If you value your watch, then wind it in a WOLF.

AXIS

PROGRAMMABLE WATCH WINDER



Powder-coated and copper plated laser cut perforated steel melded with clean, sleek lines. AXIS drives a modern, bold look for safekeeping your timepieces. Our patented technology of counting rotations of the axis of your watch guarantees precise turns per day. Bold luxury, faultless design, take AXIS for a spin.



ITEM NO: 4691
SINGLE WINDER
 COPPER / POWDER COAT

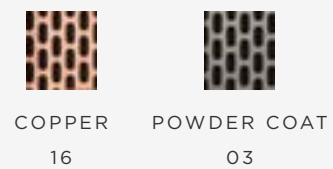

ITEM NO: 4692
SINGLE WINDER WITH STORAGE
 COPPER / POWDER COAT

ITEM NO: 4694
TRIPLE WINDER WITH STORAGE
 COPPER / POWDER COAT

ITEM NO: 4696
6PC WINDER
 COPPER / POWDER COAT

ITEM NO: 4693
DOUBLE WINDER WITH STORAGE
 COPPER / POWDER COAT

ITEM NO: 4695
4PC WINDER
 COPPER / POWDER COAT

ITEM NO: 4697
8PC WINDER
 COPPER / POWDER COAT

BRITISH RACING

PROGRAMMABLE WATCH WINDER



Classics are not created, they are born, destined to be one-off's, different, unique and above all else, timeless. British Racing has, in a very short span of time, become a classic, truly one of a kind.



ITEM NO: 7921
SINGLE WINDER WITH STORAGE
GREEN / BLACK

ITEM NO: 7922
DOUBLE WINDER WITH STORAGE
GREEN / BLACK

ITEM NO: 7923
TRIPLE WINDER WITH STORAGE
GREEN / BLACK

ITEM NO: 7930
4PC WINDER
GREEN / BLACK

ITEM NO: 7924
6PC WINDER
GREEN / BLACK

ITEM NO: 7925
8PC WINDER
GREEN / BLACK



GREEN
41



BLACK
02

MODULE 4.1

PROGRAMMABLE WATCH WINDER



The ultimate, the one, the only. 4.1 is the solution to the dilemma, "how many winders?" You own one watch no problem, you have three, we can take care of that. Once you buy another watch, buy another 4.1 winder. They connect and are powered together. Build your own watch winder tower, be creative!



ITEM NO: 454011
SINGLE WINDER
BLACK

PALERMO

PROGRAMMABLE WATCH WINDER



Sophistication must be effortless. Charm and style has to come with ease. Palermo takes cues from its namesake city on the side of a mountain by the sea. Sumptuous leathers in traditional colours with flair, black anthracite and rose gold sparkle, the Ferrari red tempts. Your watches deserves a classic home.



ITEM NO: 2137

SINGLE WATCH WINDER

PEWTER / BLACK ANTHRACITE / RED / ROSE GOLD

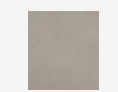

PEWTER
78



BLACK
ANTHRACITE
02



RED
72



ROSE GOLD
16

ROADSTER

PROGRAMMABLE WATCH WINDER



Take your fine timepieces for a ride in a Roadster. Aged wood dashboards, chrome spoked wheels, leather that is glove soft. Roadster - inspired by the best of British motorcars, Jaguar, Aston Martin, Bristol and the like. Turning your watch perfectly to a precise number of turns. Ebony macassar polished wood, the perfect backdrop for your watch.



ITEM NO: 457156
**SINGLE WINDER
WITH STORAGE**
BLACK

ITEM NO: 459156
4PC WINDER
BLACK

ITEM NO: 457256
**DOUBLE WINDER
WITH STORAGE**
BLACK

ITEM NO: 459256
6PC WINDER
BLACK

ITEM NO: 457056
SINGLE WINDER
BLACK

ITEM NO: 457356
**TRIPLE WINDER
WITH STORAGE**
BLACK

ITEM NO: 459356
8PC WINDER
BLACK

VICEROY

PROGRAMMABLE WATCH WINDER



Rule over your collection with authority with a timeless Viceroy watch winder. A modern classic that exudes an understated elegance. Choose from single up to 8 modules and be assured your timepiece will be wound with complete accuracy. Clockwise, anti-clockwise or both, we will take care of your watch for all time.



ITEM NO: 456102
**SINGLE WINDER
WITH STORAGE**
BLACK

ITEM NO: 456702
4PC WINDER
BLACK

ITEM NO: 456202
**DOUBLE WINDER
WITH STORAGE**
BLACK

ITEM NO: 456802
6PC WINDER
BLACK

ITEM NO: 456002
SINGLE WINDER
BLACK

ITEM NO: 456302
**TRIPLE WINDER
WITH STORAGE**
BLACK

ITEM NO: 456902
8PC WINDER
BLACK

CUB

PRE-PROGRAMMED WATCH WINDER



Young, smart and uncomplicated, our Cubs take care of your watch with ease. Six sides perfectly proportioned to encase your timepiece safely and precisely. Never miss a beat in your busy life. Choose from over 7 vegan leather colours.



ITEM NO: 4611

SINGLE CUB WITH COVER

BLACK / BROWN / NAVY / GREEN

BORDEAUX / COGNAC / ORANGE / YELLOW

ITEM NO: 461203

DOUBLE CUB WINDER WITH COVER

BLACK



BLACK
02



BROWN
06



NAVY
17



GREEN
41



BORDEAUX
26



COGNAC
27



ORANGE
39



YELLOW
92

ELEMENTS

PRE-PROGRAMMED WATCH WINDER



Drawing inspiration from the world around us, Elements uses colour and pattern in a contemporary design across watch winders, watch boxes and travel watch rolls. Choose from the blues of Water, orange and magenta of Fire or greens and browns of Earth.



ITEM NO: 6651

SINGLE CUB WINDER WITH COVER

EARTH / WATER / FIRE



EARTH
30



WATER
71



FIRE
72

MEMENTO MORI

PRE-PROGRAMMED WATCH WINDER



Celebrate life with Memento Mori. The Latin "Memento mori - remember death" is a phrase calling us not to forget that we are here for only a short time and that we must celebrate being alive. Featuring embroidered skull design on smooth vegan leather. Keep your watch alive and healthy at home and on the road.



ITEM NO: 4931
SINGLE WINDER
BLACK / RED / WHITE

ITEM NO: 4932
DOUBLE WINDER
BLACK / RED

ITEM NO: 4936
TRIPLE WINDER
BLACK



BLACK
02



RED
72



WHITE
01

NAVIGATOR

PRE-PROGRAMMED WATCH WINDER



Journey the world and always be on time. The Navigator winds your watch perfectly by counting turns per day.



ITEM NO: 462104
SINGLE WATCH WINDER
SWISS FLAG

ITEM NO: 462304
SINGLE WATCH WINDER
US FLAG

ITEM NO: 462404
SINGLE WATCH WINDER
UK FLAG



ATLAS

APP-CONTROLLED WATCH WINDER



Designed with beauty and function in mind the Atlas is forged in American steel, UL tested and certified for burglary & fire. Available in two stunning high gloss finishes of onyx or titanium and lined with LusterLoc™ to stop jewellery from tarnishing for up to 35 years. Choose from 4 to 20 winder modules (in groups of 4) to ensure that your collection keeps perfect time. Atlas is the solution for the protection of your most precious valuables.



ITEM NO: 4904
4 PIECE WINDER SAFE
ONYX / TITANIUM

ITEM NO: 4912
12 PIECE WINDER SAFE
ONYX / TITANIUM



ONYX
64



TITANIUM
65

ITEM NO: 4918
8 PIECE WINDER SAFE
ONYX / TITANIUM

ITEM NO: 4916
16 PIECE WINDER SAFE
ONYX / TITANIUM

ITEM NO: 4920
20 PIECE WINDER SAFE
ONYX / TITANIUM

CHURCHILL

APP-CONTROLLED WATCH WINDER



There is no limit to what we can craft for you. We begin with the size and configuration of the interior of the safe. You choose how many WOLF Bluetooth app controlled watch winders and the number of drawers for watches, jewellery or other valuables. We will then assist you in selecting the exterior for your safe, either sumptuous leathers or beautifully polished hardwoods. For more information and to start your Churchill design project visit www.wolf1834.com/churchill-safes



ITEM NO: 481641

CHURCHILL 16 PIECE WINDER SAFE
BRITISH RACING GREEN

ITEM NO: 481230

CHURCHILL 12 PIECE WINDER SAFE
CROCO

ITEM NO: 482440

CHURCHILL 24 PIECE WINDER SAFE
EBONY MACASSAR

ITEM NO: 481603

CHURCHILL 16 PIECE WINDER SAFE
PEBBLE BLACK LEATHER



GREEN
41



CROCO
30



EBONY
MACASSAR
40



PEBBLE
BLACK
03

REGENT

APP-CONTROLLED WATCH WINDER



Serious luxury for the watch lover in us all. Regent watch cabinets are handcrafted in wood and glass and integrated with WOLF's app to give you complete control of 12 individual watch winders. Created for true watch aficionados to protect your most precious timepieces and valuables and to keep your watches wound to perfection.



ITEM NO: 468040
12 PIECE WINDER SAFE
ZEBRA BLACK

ITEM NO: 468070
12 PIECE WINDER SAFE
BLACK



ZEBRA BLACK
40



BLACK
70



WATCH ROLLS

WOLF's luxurious and ingenious travel watch rolls combine the finest leathers with five generations of handmade tradition. Choose from single, double or triple watch rolls with secret storage compartments to keep your timepieces and valuables safe. When you travel with a WOLF watch roll, you're travelling with tradition.



AXIS



BLAKE



BRITISH RACING



ITEM NO: 4884
AXIS TRIPLE WATCH ROLL
POWDER COAT / COPPER



ITEM NO: 3050
BLAKE TRIPLE WATCH ROLL
BROWN / BLACK GREY / BLACK PURPLE

ITEM NO: 306802
BLAKE SINGLE WATCH ROLL
BLACK GREY

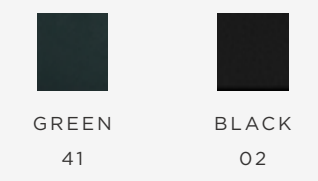

ITEM NO: 7929
BRITISH RACING TRIPLE WATCH ROLL
GREEN / BLACK

ITEM NO: 792041
BRITISH RACING SINGLE WATCH ROLL
GREEN



ELEMENTS



UK RETAIL: £199.17



MEMENTO MORI



NAVIGATOR



EARTH
30



WATER
71



FIRE
72

ITEM NO: 6652
ELEMENTS
TRIPLE WATCH ROLL
EARTH / WATER / FIRE

ITEM NO: 6653
ELEMENTS
SINGLE WATCH ROLL
EARTH / WATER / FIRE



BLACK
02



RED
72



WHITE
01

ITEM NO: 4934
MEMENTO MORI TRIPLE WATCH ROLL
BLACK / RED / WHITE



US FLAG
04



SWISS FLAG
04



UK FLAG
04

ITEM NO: 470804 / 470904 /
462504
NAVIGATOR TRIPLE WATCH ROLL
SWISS FLAG / US FLAG / UK FLAG







PALERMO



ROADSTER



			
PEWTER 78	BLACK ANTHRACITE 02	RED 72	ROSE GOLD 16

ITEM NO: 2139
PALERMO DOUBLE WATCH ROLL + JEWELLERY CASE
 PEWTER / BLACK ANTHRACITE / RED / ROSE GOLD

ITEM NO: 477856
ROADSTER TRIPLE WATCH ROLL
 BLACK



WATCH BOXES

WOLF watch boxes keep your watches safe and organised in style. Featuring suspended watch cuffs, USB charging port, storage options for cufflinks and watch straps. Available for 6, 8, 10 or 15 timepieces. Give your collection the watch box it deserves, choose WOLF.

AXIS



Powder-coated and copper plated laser cut perforated steel melded with clean, sleek lines. AXIS drives a modern, bold look for safekeeping your timepieces. Our patented technology of counting rotations of the axis of your watch guarantees precise turns per day. Bold luxury, faultless design, take AXIS for a spin.



ITEM NO: 4880
8 PIECE WATCH BOX
 COPPER / POWDER COAT

ITEM NO: 4881
10 PIECE WATCH BOX
 COPPER / POWDER COAT

ITEM NO: 4882
10 PIECE WATCH BOX WITH DRAWER
 COPPER / POWDER COAT

ITEM NO: 4883
15 PIECE WATCH BOX
 COPPER / POWDER COAT



COPPER
 16



POWDER COAT
 03

BRITISH RACING



Classics are not created, they are born, destined to be one-off's, different, unique and above all else, timeless. British Racing has, in a very short span of time, become a classic, truly one of a kind.



ITEM NO: 7926
8PC WATCH BOX
GREEN / BLACK

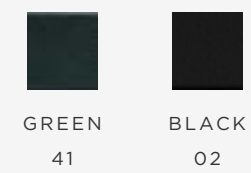

ITEM NO: 7927
10PC WATCH BOX
GREEN / BLACK

ITEM NO: 7928
10PC WATCH BOX WITH STORAGE
GREEN / BLACK

ELEMENTS



Drawing inspiration from the world around us, Elements uses colour and pattern in a contemporary design in our classic 10 piece watch box. Choose from the blues of Water, orange and magenta of Fire or greens and browns of Earth.



ITEM NO: 6654
10 PIECE WATCH BOX
EARTH / WATER / FIRE



EARTH
30



WATER
71



FIRE
72

MEMENTO MORI



Celebrate life with Memento Mori. The Latin "Memento mori - remember death" is a phrase calling us to not forget that we are here for only a short time and that we must celebrate being alive. Featuring embroidered skull design on smooth vegan leather. Keep your watch alive and healthy at home and on the road.



ITEM NO: 4935
10 PIECE WATCH BOX
BLACK / RED / WHITE



BLACK
02



RED
72



WHITE
01

PALERMO



Sophistication must be effortless. Charm and style has to come with ease. Palermo takes cues from its namesake city on the side of a mountain by the sea. Sumptuous leathers in traditional colours with flair, black anthracite and rose gold sparkle, the Ferrari red tempts. Your watches deserve a classic home.



ITEM NO: 2138

6 PIECE WATCH BOX

ROSE GOLD / BLACK ANTHRACITE / RED / PEWTER



ROSE GOLD

16



BLACK
ANTHRACITE

02



RED

72



PEWTER

78

ROADSTER



Take your fine timepieces for a ride in a Roadster. Aged wood dashboards, chrome spoked wheels, leather that is glove soft. Roadset - inspired by the best of British motorcars, Jaguar, Aston Martin, Bristol and the like. The ebony macassar polished wood in our 8, 10 and 15 piece watchboxes, provides the perfect backdrop for your watch collection.



ITEM NO: 477556
10PC WATCH BOX
BLACK

ITEM NO: 477656
10PC WATCH BOX
WITH STORAGE
BLACK

ITEM NO: 477456
8PC WATCH BOX
BLACK

ITEM NO: 477756
15PC WATCH BOX
BLACK

VICEROY



View your collection in a timeless Viceroy watch box. A modern classic that exudes an understated elegance. Choose from 8 piece, 10 piece with storage draw option and 15 piece boxes, taking care of your watch with effortless style.

WATCH BOXES



ITEM NO: 466102
10PC WATCH BOX
BLACK

ITEM NO: 466202
10PC WATCH BOX
WITH DRAWER
BLACK

ITEM NO: 466002
8PC WATCH BOX
BLACK

ITEM NO: 466302
15PC WATCH BOX
BLACK



JEWELLERY BOXES

WOLF's refined jewellery cases combine the finest materials with over five generations of handmade tradition. Interiors treated with patented LusterLoc™ and compartments designed for every piece in your collection keep your jewellery sparkling and ready to wear. With many styles and finishes to choose from WOLF safely stores your jewellery at home or on the go. From embroidered florals to classic leathers WOLF offers the perfect jewellery box for everyone.

CAROLINE



The embodiment of sophistication and style. Caroline, a timeless classic with elegant soft lines of the 50's, supple diamond quilted leather accented with gold hardware. A refined case and home for your precious jewellery and heirlooms. Travel with Caroline makes safekeeping your jewellery whilst on the go a snap. Choose from classic ivory to chic black. Your style, your case.



ITEM NO: 3297
MEDIUM JEWELLERY BOX
 RED / BLACK / IVORY / ROSE QUARTZ

ITEM NO: 3296
LARGE JEWELLERY BOX
 RED / BLACK / IVORY / ROSE QUARTZ

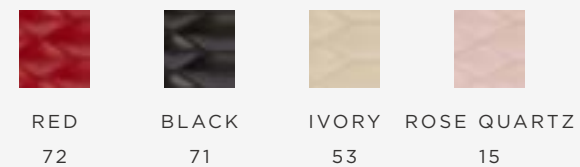

ITEM NO: 3295
EXTRA LARGE JEWELLERY BOX
 RED / BLACK / IVORY / ROSE QUARTZ

MARRAKESH



Take a trip to an exotic and intoxicating place, leather and gold studding whirling together, creating patterns within patterns. Elegant cream or dramatic black leather is your choice. Make a statement at home or travel with chic-charm with a travel or zip case. Release the dervish in you!



ITEM NO: 3084
SAFE DEPOSIT BOX
 CREAM / BLACK

ITEM NO: 3083
FLAT JEWELLERY BOX
 CREAM / BLACK

ITEM NO: 3081
MEDIUM JEWELLERY BOX
 CREAM / BLACK

ITEM NO: 3082
LARGE JEWELLERY BOX
 CREAM / BLACK



CREAM
 53



BLACK
 02

PALERMO







Sophistication must be effortless. Charm and style has to come with ease. Palermo takes cues from its namesake city on the side of a mountain by the sea. Sumptuous leathers in traditional colours with flair, black anthracite and rose gold sparkle, the Ferrari red tempts. Your jewellery deserves a classic home.



ITEM NO: 2135
SAFE DEPOSIT BOX
 ROSE GOLD / BLACK ANTHRACITE / RED / PEWTER

ITEM NO: 2132
MEDIUM JEWELLERY BOX
 ROSE GOLD / BLACK ANTHRACITE / RED / PEWTER

- | | | | |
|---|---|---|---|
|  |  |  |  |
| ROSE GOLD
16 | BLACK
ANTHRACITE
02 | RED
72 | PEWTER
78 |

ITEM NO: 2130
LARGE JEWELLERY BOX
 ROSE GOLD / BLACK ANTHRACITE / RED / PEWTER

SOPHIA



Where classic meets contemporary, function meets fashion, Sophia is designed to protect charms and charm jewellery in style. Each handmade charm jewellery box is treated with our patented LusterLoc™ anti-tarnish lining to keep your jewellery for the collections from Pandora, Thomas Sabo and many others looking its best at all times.



ITEM NO: 3924

JEWELLERY BOX WITH WINDOW
JADE / FOREST GREEN / INDIGO

ITEM NO: 3920

JEWELLERY BOX WITH DRAWERS
JADE / FOREST GREEN / INDIGO



JADE
30



FOREST GREEN
12



INDIGO
17

VAULT



Create your own custom jewellery box with Vault's clean lines and classic design. The range of Vault stacking trays and inserts lets you decide how to organise your jewellery storage to care for your collections. Made from Vegan leather in stylish black, grey, or ivory, your jewellery will be protected from tarnishing for 35 years in Vault; every insert is lined with LusterLoc™ treated Ultrasuede.

1. SELECT A LID



VAULT
GLASS TRAY LID
BLACK



VAULT
GLASS TRAY LID
IVORY



VAULT
GLASS TRAY LID
GREY



VAULT
TRAY LID
BLACK



VAULT
TRAY LID
IVORY



VAULT
TRAY LID
GREY

2. SELECT TRAY



VAULT
1.5" TRAY
BLACK



VAULT
1.5" TRAY
IVORY



VAULT
1.5" TRAY
GREY



VAULT
2" TRAY
BLACK



VAULT
2" TRAY
IVORY



VAULT
2" TRAY
GREY



VAULT
4" TRAY
BLACK



VAULT
4" TRAY
IVORY



VAULT
4" TRAY
GREY

VAULT

3. SELECT INSERTS



ITEM NO: 436670
WATCH STRAP INSERT

ITEM NO: 437870
**MULTI-COMPARTMENT AND
EARRING HALF INSERT**

ITEM NO: 437670
NECKLACE HALF INSERT

ITEM NO: 435670
EARRING INSERT

ITEM NO: 435870
RING INSERT

ITEM NO: 436770
SUNGLASS INSERT

ITEM NO: 437770
**MULTI-COMPARTMENT AND
RING HALF INSERT**

ITEM NO: 437570
BRACELET HALF INSERT

ITEM NO: 435770
NECKLACE INSERT

ITEM NO: 435570
BRACELET INSERT

ITEM NO: 436570
WATCH INSERT

ITEM NO: 4351
1.5" STANDARD TRAY

ITEM NO: 4350
2" DEEP TRAY

ITEM NO: 4352
4" DEEP TRAY

VAULT



	<p>IVORY</p>  <p>STANDARD LID ITEM NO: 434953</p>	<p>GREY</p>  <p>GLASS LID ITEM NO: 435365</p>
<p>BLACK</p>  <p>GLASS LID ITEM NO: 435302</p>	 <p>1" HALF INSERT TRAY - RING ITEM NO: 437570</p>	 <p>.75" BRACELET INSERT ITEM NO: 437570</p>
 <p>.75" INSERT - NECKLACE ITEM NO: 437670</p>	 <p>1" HALF INSERT TRAY - EARRING ITEM NO: 436670</p>	 <p>2.25" SUNGLASSES INSERT ITEM NO: 436770</p>
 <p>1.5" VAULT TRAY ITEM NO: 435102</p>	 <p>2" VAULT TRAY ITEM NO: 435053</p>	 <p>4" VAULT TRAY ITEM NO: 435265</p>

1. SELECT A LID 2. SELECT A TRAY 3. SELECT INSERTS

1.5" STANDARD VAULT TRAY
INSERT OPTION SHOWN
1.) 1 X .75" INSERT

2" DEEP VAULT TRAY
INSERT OPTION SHOWN
1.) 2 X 1" HALF INSERTS

4" DEEP VAULT TRAY
INSERT OPTION SHOWN
1.) 1 X SUNGLASS INSERT &
1 X .75" INSERT

ZOE



Fresh faced and fun, Zoe is sophisticated but playful. Soft mink, indigo or forest green velvet bodies highly embroidered with classic floral designs. A trend that is here to stay whilst at home or on the go.



ITEM NO: 3931
MEDIUM JEWELLERY BOX
FOREST GREEN / INDIGO

ITEM NO: 3930
LARGE JEWELLERY BOX
FOREST GREEN / INDIGO



FOREST GREEN

12



INDIGO

16



TRAVEL CASES

WOLF's jewellery travel cases are the perfect solution to keep your jewellery safe and ready to wear while you are on your travels. Every case interior is treated with our patented LusterLoc™ and with many sizes, styles and finishes to choose from you will be spoilt for choice. WOLF simply offers the perfect jewellery travel cases for everyone.

CAROLINE

The embodiment of sophistication and style. Caroline, a timeless classic with elegant soft lines of the 50's, supple diamond quilted leather accented with gold hardware. Travel with Caroline makes safekeeping your jewellery whilst on the go a snap. Choose from the small zip travel case or jewellery portfolios, available in Ferrari red, black, ivory or rose quartz. Your style your case.



ITEM NO: 3299
ZIP TRAVEL CASE
 RED / BLACK / IVORY / ROSE QUARTZ

ITEM NO: 3248
JEWELLERY PORTFOLIO
 RED / BLACK / IVORY / ROSE QUARTZ



ITEM NO: 3240
LARGE JEWELLERY PORTFOLIO
 RED / BLACK / IVORY / ROSE QUARTZ

MARIA



A new classic is born with Maria. Pure sophistication with clean lines and just the right amount of detail. Maria is inspired by and for the traveller in love with cities they've never been to and people they've never met. Our first complete travel collection wrapped in rich smooth leathers and stunning gold accents. Maria is perfect for keeping jewellery in place with style; for business, leisure and everything in between.



ITEM NO: 7665
SMALL JEWELLERY CUBE
 NAVY / WHITE / MUSTARD

ITEM NO: 7662
SMALL ZIP CASE
 NAVY / WHITE / MUSTARD

ITEM NO: 7664
JEWELLERY PORTFOLIO
 NAVY / WHITE / MUSTARD

ITEM NO: 7663
MEDIUM ZIP CASE
 NAVY / WHITE / MUSTARD

NAVY 17
 WHITE 53
 MUSTARD 93

ITEM NO: 7661
LARGE ZIP CASE
 NAVY / WHITE / MUSTARD

MARRAKESH



Take a trip to an exotic and intoxicating place, leather and gold studding whirling together, creating patterns within patterns. Elegant cream or dramatic black leather is your choice. Make a statement when you travel with chic-charm with a travel or zip case. Release the dervish in you!



ITEM NO: 3085
TRAVEL CASE
CREAM / BLACK



CREAM
53



BLACK
02

ITEM NO: 3086
ZIP CASE
CREAM / BLACK

PALERMO







Sophistication must be effortless. Charm and style has to come with ease. Palermo takes cues from its namesake city on the side of a mountain by the sea. Sumptuous leathers in traditional colours with flair, black anthracite and rose gold sparkle, the Ferrari red tempts. Your jewellery deserves a classic home.



ITEM NO: 2139
DOUBLE WATCH ROLL + JEWELLERY CASE
 PEWTER / BLACK ANTHRACITE / RED / ROSE GOLD

ITEM NO: 2134
JEWELLERY ROLL
 PEWTER / BLACK ANTHRACITE / RED / ROSE GOLD

ITEM NO: 2136
ZIP CASE
 PEWTER / BLACK ANTHRACITE / RED / ROSE GOLD

- 
 PEWTER
78
- 
 BLACK ANTHRACITE
02
- 
 RED
72
- 
 ROSE GOLD
16

SOPHIA





Where classic meets contemporary, function meets fashion, Sophia is designed to protect charms and charm jewellery in style. Each handmade charm jewellery box is treated with our patented LusterLoc™ anti-tarnish lining to keep your jewellery for the collections from Pandora, Thomas Sabo and many others looking its best at all times.



ITEM NO: 3923
ROUND ZIP CASE
JADE / FOREST GREEN / INDIGO

ITEM NO: 3922
TRAVEL ZIP CASE
JADE / FOREST GREEN / INDIGO

- | | | |
|---|---|---|
|  |  |  |
| JADE
30 | FOREST GREEN
12 | INDIGO
17 |

ZOE



Fresh faced and fun, Zoe is sophisticated but playful. Soft mink, indigo or forest green velvet bodies highly embroidered with classic floral designs. A trend that is here to stay. Choose from our travel round, zip case or portfolio and travel in style for your next holiday.

TRAVEL CASES



ITEM NO: 3932
TRAVEL ROUND
FOREST GREEN / INDIGO

ITEM NO: 3933
TRAVEL ZIP CASE
FOREST GREEN / INDIGO



FOREST GREEN
12



INDIGO
16

ITEM NO: 3934
JEWELLERY PORTFOLIO
FOREST GREEN / INDIGO



SAFES

The 1834 Safe Collection is the next level of WOLF's commitment to protecting your most precious valuables. Our meticulously crafted safes are made to provide the ultimate in security while upholding WOLF's iconic design identity of melding beauty and functionality. In addition to our standard collection we offer a completely bespoke experience that allows you to choose leather, hardware colour, and interior configurations, ensuring that your taste is matched perfectly.



ATLAS



Designed with beauty and function in mind the Atlas is forged in American steel, UL tested and certified for burglary & fire. Available in two stunning high gloss finishes of onyx or titanium and lined with LusterLoc™ to stop jewellery from tarnishing for up to 35 years. Choose from 4 to 20 winder modules (in groups of 4) to ensure that your collection keeps perfect time. Atlas is the solution for the protection of your most precious valuables.



ITEM NO: 4904
4 PIECE WINDER SAFE
 ONYX / TITANIUM

ITEM NO: 4918
8 PIECE WINDER SAFE
 ONYX / TITANIUM

ITEM NO: 4912
12 PIECE WINDER SAFE
 ONYX / TITANIUM

ITEM NO: 4916
16 PIECE WINDER SAFE
 ONYX / TITANIUM

 ONYX 64
 TITANIUM 65

ITEM NO: 4920
20 PIECE WINDER SAFE
 ONYX / TITANIUM

STYLES & FEATURES

HIGH-GLOSS FINISHES

Atlas is available in both finishes.



ONYX
Matte Black Interior 64



TITANIUM
Matte Black Interior 65

ATLAS

Weight: 331 kgs

Dimensions:

22W x 24D x 40H in
55.9W x 61D x 101.6H cm

Customisable to meet your needs. Select the number of winding modules, drawers and drawer configurations.

For more information go to WOLF1834.com and customise your Atlas today!

FEATURES

- Store watches, jewellery, documents, etc.
- UL certified independent testing
- Bluetooth user-controlled app
- Rotation Options: 1-1,999 turns per day
- Directional Settings: clockwise, counter clockwise, or bi-directional
- Start Delay: Up to 255-hour delay
- Patented lock-in cuff design
- Custom 1834 grey LusterLoc™ treated ultrasuede interior



UL CERTIFIED INDEPENDENT TESTING

Verified Fire Resistance:

- For up to 120 minutes, tested at 1,700°F (927°C), then dropped from 30 feet.
- The interior temperature during the fire test remains below 350°F (177°C), (paper burns at 450°F (232°C), so your documents remain safe.

Verified Water Resistance:

- The interior of the safe door is sealed with Palusol® fire seal which expands 8 times the original size, sealing the door.

BLUETOOTH USER-CONTROLLED APP

- Effortlessly control winder modules either independently or simultaneously with WOLF app (download on the App Store or get it on Google Play).
- Customise your safe with the ability to name the safe and each winder.
- Upload your watches or personal photos as background image.
- i-Mode feature controls LED light with the ability to set on/off timers based on your schedule.
- Password-protected app control.
- Register your warranty from your phone.
- Contact customer service and shop online.

CHURCHILL

Experience the world of bespoke safes with Churchill. Crafted by WOLF and made for you. Forged in steel with 9 bi-directional steel bolts, secure electronic Sargent and Greenleaf keypads. Providing the ultimate in security while upholding WOLF's iconic design identity of melding beauty and functionality. Select the leather, hardware colour and interior configurations of drawers and winders to ensure you bring home a piece as unique as you.

WOODS AND LEATHERS
AVAILABLE IN YOUR CHOICE OF
TEXTURE AND COLOUR



CHOOSE HOW MANY BLUETOOTH APP CONTROLLED WATCH WINDERS AND THE NUMBER OF DRAWERS FOR WATCHES, JEWELLERY OR OTHER VALUABLES.



A close-up photograph of a brass keyhole on a dark green, textured safe door. The keyhole is cylindrical and protrudes from the door. The texture of the door is a fine, pebbled grain. The lighting is dramatic, highlighting the metallic sheen of the brass and the texture of the door.

SECURITY

Forged Steel Plates

9 Independent Bolts

Sargent and Greenleaf Keypads

CHURCHILL



There is no limit to what we can craft for you. We begin with the size and configuration of the interior of the safe. You choose how many WOLF Bluetooth app controlled watch winders and the number of drawers for watches, jewellery or other valuables. We will then assist you in selecting the exterior for your safe, either sumptuous leathers or beautifully polished hardwoods. For more information and to start your Churchill design project visit www.wolf1834.com/churchill-safes



ITEM NO: 481641
CHURCHILL 16 PIECE WINDER SAFE
 BRITISH RACING GREEN

ITEM NO: 481230
CHURCHILL 12 PIECE WINDER SAFE
 CROCO

ITEM NO: 482440
CHURCHILL 24 PIECE WINDER SAFE
 EBONY MACASSAR

- 
 GREEN
41
- 
 CROCO
30
- 
 EBONY
MACASSAR
40
- 
 PEBBLE
BLACK
03

ITEM NO: 481603
CHURCHILL 16 PIECE WINDER SAFE
 PEBBLE BLACK LEATHER

STYLES & FEATURES

CHURCHILL

FEATURES

- Bluetooth user-controlled app
- Rotation Options: 1-1,999 turns per day
- Directional Settings: clockwise, counter clockwise, or bi-directional
- Start Delay: Up to 255-hour delay
- Return to start
- Patented lock-in cuff design
- 10 additional watch storage
- Luxurious nubuck leather interior
- Exceeds standards for S1 - S2 NH rating awarded by insurance companies

BLUETOOTH USER-CONTROLLED APP

- Effortlessly control winder modules either independently or simultaneously with WOLF app (download on the App Store or get it on Google Play).
- Customise your safe with the ability to name the safe and each winder.
- Upload your watches or personal photos as background image.
- i-Mode feature controls LED light with the ability to set on/off timers based on your schedule.
- Password-protected app control.
- Register your warranty from your phone.
- Contact customer service and shop online.



BRITISH RACING GREEN

Leather wrapped: safe

Wood encased: cabinet

Dimensions:

78W x 56D x 167H cm

16 PIECE



PEBBLE

Leather wrapped: safe

Wood encased: cabinet

Dimensions:

74W x 54D x 165H cm

16 PIECE



MACASSAR

Leather wrapped: safe

Wood encased: cabinet

Dimensions:

74W x 54D x 165H cm

24 PIECE



LUXURY ACCESSORIES

WOLF's range of luxury accessories for men and women includes wallets and bill folds, travel accessories, tech cases and bags. All designed innovatively to provide protection for your precious items with RFID in wallets and clever detailing for your travels. Classic beautiful design made from the finest leather alongside innovative sustainable materials made from apple pulp and recycled plastic bottles, luxury with a conscience.



Mimi is for the woman on the go who needs her essentials close but wants to be free of bulky handbags. Inspired by both high runway fashion moments of the 90's and ancient Japanese Sagemonos, Mimi helps you travel light so you can go about your day in style.



ITEM NO: 7681
EARPODS CASE WITH WRISTLET
 MARINE / FOREST GREEN / RED / PINK / BLACK

ITEM NO: 7682
CREDIT CARD HOLDER WITH WRISTLET
 MARINE / FOREST GREEN / RED / PINK / BLACK

ITEM NO: 7683
CROSSBODY BAG WITH WRISTLET AND LANYARD
 MARINE / FOREST GREEN / RED / PINK / BLACK

ITEM NO: 7684
MINI BAG WITH WRISTLET AND LANYARD
 MARINE / FOREST GREEN / RED / PINK / BLACK

ITEM NO: 7685
PHONE CASE WITH WRISTLET AND LANYARD
 MARINE / FOREST GREEN / RED / PINK / BLACK

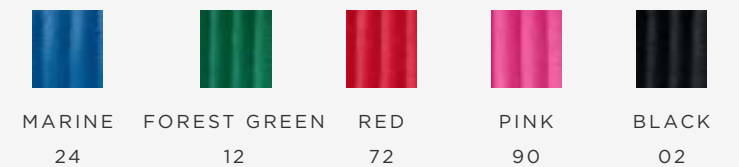

SIGNATURE



The Signature Collection is designed for the world traveller who cares about the planet that they travel around. The collection is vegan, 95% sustainable and is made from recycled materials including apple pulp and plastic bottles. Inspired by vintage luggage, the collection is made with a fully recycled PVC exterior. The collection features wallets, card cases, travel accessories and laptop cases, all finished with a monogram pattern, gold hardware and has a RFID protection lining to ensure personal data is protected.



ITEM NO: 7760
BILFOLD
 BROWN / GREEN / ORANGE / BLUE

ITEM NO: 7762
CARDHOLDER
 BROWN / GREEN / ORANGE / BLUE

ITEM NO: 7764
ZIP WALLET
 BROWN / GREEN / ORANGE / BLUE

ITEM NO: 7761
BILFOLD AND COIN
 BROWN / GREEN / ORANGE / BLUE

ITEM NO: 7763
ID CARD CASE
 BROWN / GREEN / ORANGE / BLUE

ITEM NO: 7765
ZIP CARD CASE
 BROWN / GREEN / ORANGE / BLUE

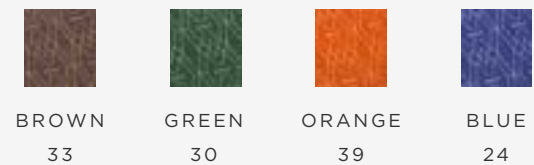

SIGNATURE

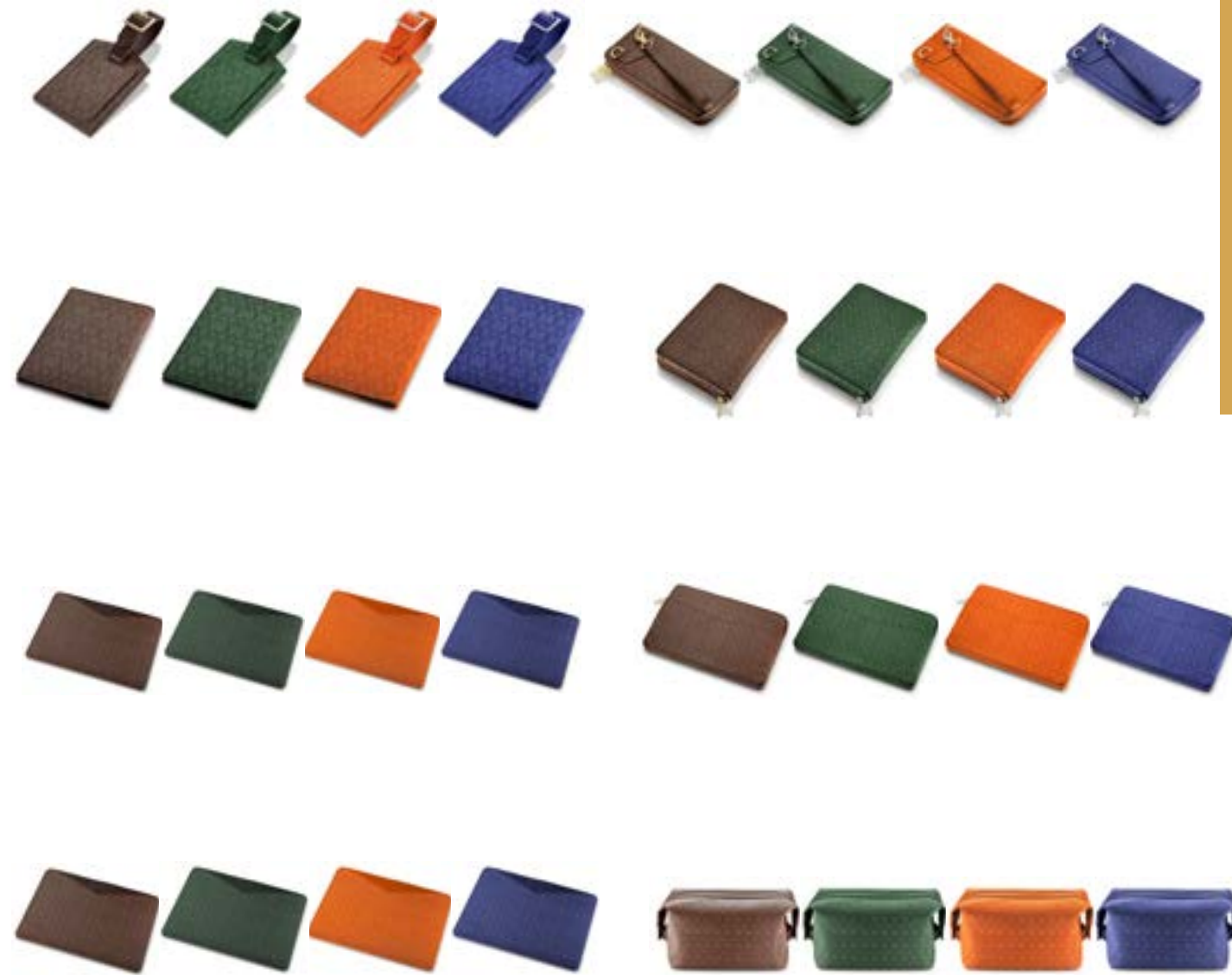

ITEM NO: 7767
LUGGAGE TAG
 BROWN / GREEN / ORANGE / BLUE

ITEM NO: 7769
IPAD TECH CASE
 BROWN / GREEN / ORANGE / BLUE

ITEM NO: 7770
13" LAPTOP SLEEVE
 BROWN / GREEN / ORANGE / BLUE

ITEM NO: 7771
16" LAPTOP SLEEVE
 BROWN / GREEN / ORANGE / BLUE

ITEM NO: 7768
TRAVEL CASE
 BROWN / GREEN / ORANGE / BLUE

ITEM NO: 7766
PASSPORT SLEEVE
 BROWN / GREEN / ORANGE / BLUE

ITEM NO: 7773
16" LAPTOP ZIP CASE
 BROWN / GREEN / ORANGE / BLUE

ITEM NO: 7772
WASH BAG
 BROWN / GREEN / ORANGE / BLUE

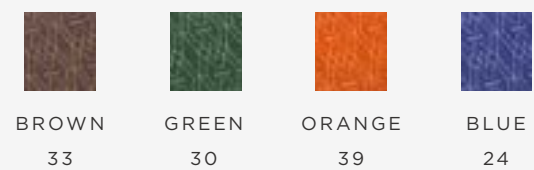



The W Collection is a luxurious, sleek, and sophisticated leather accessories collection for the modern man. Crafted with embossed grain and sustainably sourced leather, our gold W logo and deep green lining. The collection includes wallets, business accessories and a wash bag all designed with meticulous attention to detail and timeless, sophisticated design.



ITEM NO: 774202
CARDHOLDER
BLACK

ITEM NO: 774402
GUSSET CARD CASE
BLACK

ITEM NO: 774002
BILLFOLD WALLET
BLACK

ITEM NO: 774302
ID CARD CASE
BLACK

ITEM NO: 774602
LAPTOP SLEEVE
BLACK

ITEM NO: 774102
BILLFOLD AND COIN WALLET
BLACK

ITEM NO: 774502
MOULDED CARD
BLACK

ITEM NO: 774702
WASH BAG
BLACK



COLLABORATIONS

As the saying goes “a perfect match, made in heaven” and so it is with the utmost of consideration that we choose the company we keep. Our collaborations are rare and highly selective, Harrods, Bea Bongiasca, Analog/Shift and WM Brown grace the following pages with innovative design twists that give a perfect nod to both brands.

Analog/Shift, leading retailer of vintage and contemporary timepieces based in New York City, have teamed up with WOLF, experts in watch care for over 185 years, to bring you beautiful modern interpretations of famous historical boxes with this limited edition collection.

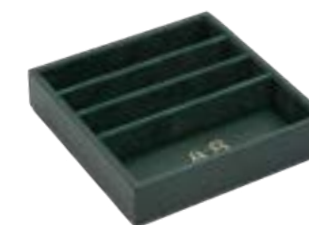

ITEM NO: 708041
10 PIECE WATCH BOX
 GREEN

ITEM NO: 708141
STRAP CHANGING TRAY
 GREEN

ITEM NO: 710212
5 PIECE WATCH BOX
 WALNUT

ITEM NO: 710211
5 PIECE WATCH BOX
 NATURAL

ITEM NO: 709361
STRAP CHANGING TRAY
 CORK

ITEM NO: 709261
8 PC WATCH BOX
 CORK



GREEN
 41



WALNUT
 12



NATURAL
 21



CORK
 61

BEA BONGIASCA



WOLF continues to revolutionise the art of crafting boxes in this collaboration with innovative jewellery designer Bea Bongiasca. Inspired by seventies swagger, the collection consists of jewellery boxes, jewellery trays with lids and travel-ready mini jewellery cases all in eye-popping colour combinations and kaleidoscopic patterns.



ITEM NO: 882001 / 882002 / 882003

SMALL JEWELLERY BOX

YELLOW BLUE PURPLE / BLUE PINK YELLOW / PINK GREEN BLUE

ITEM NO: 882004 / 882005 / 882006

SMALL JEWELLERY TRAY

RED BLUE / GREEN PURPLE / PINK YELLOW

ITEM NO: 882010 / 882011 / 882012

MEDIUM JEWELLERY TRAY

BLUE PINK YELLOW / GREEN PURPLE BLUE / RED BLUE PURPLE

ITEM NO: 882007 / 882008

MEDIUM JEWELLERY BOX

PINK RED BLUE / GREEN PINK YELLOW

ITEM NO: 882009

LARGE JEWELLERY BOX

GREEN PINK YELLOW

CASSANDRA



Explore the luxurious Cassandra collaboration with Harrods. Elegant, timeless and handcrafted to last a lifetime, Cassandra encompasses all that is the classic British woman.



ITEM NO: 800844 / 800845
JEWELLERY AND WATCH ROLL
HUNTER GREEN / COGNAC

ITEM NO: 800846 / 800847
JEWELLERY PORTFOLIO
HUNTER GREEN / COGNAC

ITEM NO: 800842 / 800843
JEWELLERY BOX
HUNTER GREEN / COGNAC

WM BROWN



Known for his impeccable taste in fashion and love of watches Matt Hranek founder and editor of WM Brown has partnered with WOLF to craft a collection of products made for the modern man. The collection features WOLF's signature watch winders, watch boxes, and watch rolls infused with WM Brown's iconic Negroni Tweed. Negroni tweed was created in an English wool mill by the Fox Brothers for Matt & WM Brown in celebration of the delicious Negroni cocktail.



ITEM NO: 800672
5 PIECE WATCH BOX
BROWN

ITEM NO: 800688
SHOE SHINE CASE
BROWN

ITEM NO: 800685
WATCH ROLL WITH CIGAR CASE
BROWN

ITEM NO: 800687
SET OF 4 COASTERS
BROWN

ITEM NO: 800689
NEGRONI ASTUCCIO BEVERAGE
BROWN

ITEM NO: 800670
SINGLE WINDER
BROWN

ITEM NO: 800686
HUMIDOR
BROWN

ITEM NO: 800692
SNAP COIN / VALET TRAY
BROWN

